

VOLVO EXCAVATORS

EC160D, EC180D

16,2-20,2 t 143 hp



A PASSION FOR PERFORMANCE.

At Volvo Construction Equipment, we're not just coming along for the ride. Developing products and services that raise productivity – we are confident we can lower costs and increase profits for industry experts. Part of the Volvo Group, we are passionate about innovative solutions to help you work smarter – not harder.

Helping you to do more

Doing more with less is a trademark of Volvo Construction Equipment. High productivity has long been married to low energy consumption, ease of use and durability. When it comes to lowering life-cycle costs, Volvo is in a class of its own.

Designed to fit your needs

There is a lot riding on creating solutions that are suited to the particular needs of different industry applications. Innovation often involves high technology – but it doesn't always have to. Some of our best ideas have been simple, based on a clear and deep understanding of our customers' working lives.



You learn a lot in 175 years

Over the years, Volvo has advanced solutions that have revolutionized the use of construction equipment. No other name speaks Safety louder than Volvo. Protecting operators, those around them and minimizing our environmental impact are traditional values that continue to shape our product design philosophy.

We're on your side

We back the Volvo brand with the best people. Volvo is truly a global enterprise, one that is on standby to support customers quickly and efficiently – wherever they are.

We have a passion for performance.

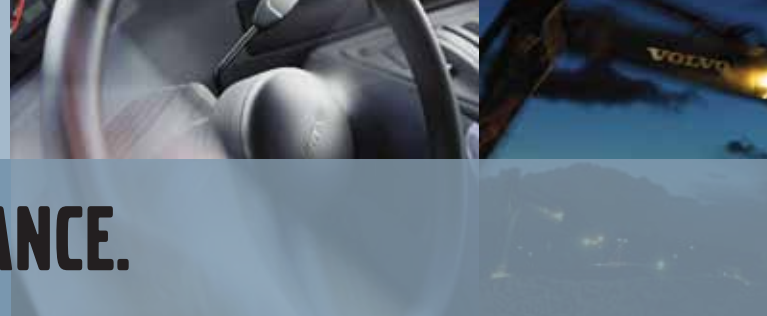

Volvo Trucks

Renault Trucks

Mack Trucks



UD Trucks

Volvo Buses

Volvo Construction Equipment

Volvo Penta

Volvo Aero

Volvo Financial Services

DESIGNED FOR EFFICIENCY.

Introducing Volvo's powerful, fuel efficient and environmentally responsible D-Series crawler excavators. Featuring Volvo's unique, award-winning ECO mode, the D4 Stage IIIB/ Tier 4 Interim engine and improved hydraulics, these machines deliver reduced fuel consumption and cycle times resulting in up to 14% rise in fuel efficiency improvement as well as increased digging performance.

Volvo D4 Stage IIIB/ Tier 4 Interim engine

Volvo's new fuel efficient engine features an active-type Diesel Particulate Filter (DPF) and a regeneration process to lower emissions. The unique method does not interrupt operation, performance or productivity.

ECO mode

Volvo's unique, award-winning ECO mode features sophisticated electronic pump control technology which contributes to up to 5% of the machine's total improved fuel efficiency without any loss of performance in most operating conditions.

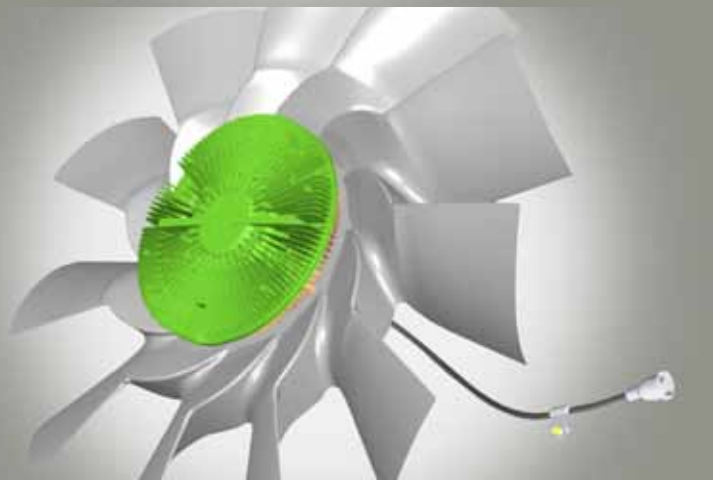

Work modes

Operators can select the best work mode for the task at hand to ensure optimum performance and fuel efficiency. Choose the correct mode according to your working conditions for added versatility and increased performance.

Proportional controlled viscous-clutch

Optimized fan speed control from the new proportional controlled viscous-clutch for reduced fuel consumption.



Fuel efficiency

For ultimate fuel efficiency Volvo's efficient diesel engine, enhanced hydraulic system and well matched components give you more power, while consuming less fuel. Volvo's D4 Stage IIIB/ Tier 4 Interim engine features low emission levels for increased environmental care.

CONTROL IN COMFORT.



Volvo Care Cab

All-round visibility and a premium operator environment are at the heart of Volvo's cab design. The spacious cab, with ample storage and leg room, features an adjustable seat for excellent operator comfort, reduced whole body vibration and increased productivity.

Step inside Volvo's care cab and enjoy excellent all-round visibility. In this safe and comfortable environment operators will feel efficient and in control all day long. See more and do more with Volvo.

Rubber/Silicone oil viscous mounts

Spring is added to the mounts to improve shock absorption and reduce vibration. Increased operator comfort means more productivity.

I-ECU monitor

Large color monitor provides excellent clarity in all light conditions. Using a control panel the operator and service technician can make quick visual and diagnostic checks, increasing uptime and productivity. The monitor also displays camera images – up to four at a time.

ROPS

The cab features Roll Over Protective Structure (ROPS) which meets the ISO 12117-2 safety standard for increased peace of mind in the unlikely event of machine roll over.



Smart consoles and switches

High quality consoles and conveniently located switches for easy access and improved operator efficiency.

Automatic climate control system

Operators can set their ideal temperature with Volvo's powerful climate control system. Industry leading air circulation and defrosting capability is delivered with 14 well-spaced vents for increased comfort and productivity.

Rear view camera

Rear view camera provides visibility via the color I-ECU monitor for increased safety. The camera sits on top of the counterweight to project the area behind the machine.

CONTROL IT. FASTER.

Volvo gives you more. More power, more capacity and more weight – command the new D-Series crawler excavators to handle your workload and enjoy increased total performance from our improved hydraulic system. Trust Volvo to put you in control.

Digging power and speed

Enhanced digging force and faster cycle times, particularly when working with hard materials, from increased engine power and improved hydraulics.



Lifting capacity

Excellent lifting capacity and stability allows the machine to lift heavier objects ensuring greater productivity.



Grading

Superb grading performance from improved hydraulic system. Effortlessly smooth surfaces with harmonized flow control and well-matched attachment speed.

Attachment Management System

Allows storage of up to 18 different attachment presets and permits hydraulic flow (standard) and pressure (optional) to be adjusted to enable the use of various attachments for increased versatility. Operators can change attachments quickly without manual setup.



Controllability

Smart hydraulic system enables smooth and highly responsive combined operation and travel. The system automatically prioritizes oil flow to the boom, arm or slew function according to requirements, resulting in faster cycle times.

SERVICEABILITY. SIMPLIFIED.



Serviceability

Grouped filters and accessible radiators are quick to access from ground level via large, wide compartment doors – increasing safety. Easy access for maintenance means regular checks get done faster, giving you more uptime.

With built in serviceability the new Volvo D-Series crawler excavators guarantee you more uptime. Easy access to grouped service points allows for fast and effortless maintenance and service checks. Achieve more with Volvo.

Grouped filters

Grouped, ground level filters in the pump compartment are accessible via one door for faster servicing and more machine uptime. This reduces the need for conducting maintenance at height, increasing safety.

Rear access

Rear entry behind the cab grants safe and convenient access to the main hydraulic components and engine. Newly designed stairway allows for access to the top of the superstructure.



Service intervals on I-ECU

A service mode is incorporated into the I-ECU color monitor to enable diagnostic checks. Four separate service intervals – the engine oil/filter, fuel filter/water separator, hydraulic oil and hydraulic oil filter – are displayed on the monitor.

Stays and locking devices

Volvo's automatic stays prevent doors being blown closed for added safety, they can easily be manually released. Automatic locks ensure the doors close properly and enhance appearance.

TOP PERFORMANCE DESERVES SUPPORT.

The day you receive your new Volvo Excavator is just the start of your working relationship with Volvo. From service and maintenance to our CareTrack telematics system – Volvo has a comprehensive and sophisticated aftermarket portfolio to continuously add value to your business.

Volvo designed and built your machines, so no-one knows how to keep them working in top condition more than us. When it comes to your machine, our Volvo trained technicians are the experts.

Our technicians work with industry leading diagnostic tools and techniques, using only Genuine Volvo Parts to deliver the highest levels of quality and service. Talk to your Volvo dealer about how genuine Volvo services can best provide the service and maintenance plan that is the right fit for you and your business.



State-of-the-art machines require state-of-the-art support and your Volvo dealer can provide a catalogue of services designed to get the most out of your machine, helping you maximise uptime, productivity and residual value. Your Volvo dealer can provide a number of sophisticated support offers, including:

Service plans ranging from routine wear inspections, through to comprehensive maintenance and repair agreements.

Analysis and diagnostics to help you understand how your machine is running, highlight potential maintenance issues and identify where performance can be improved.

Eco Operator training courses can help your operators work towards a safer, more productive and fuel efficient performance.



CareTrack*

Each Volvo Excavator comes standard equipped with CareTrack, the Volvo telematics system. CareTrack provides information for better planning and smarter working; including fuel consumption reports, location reports and service reminders. Save fuel. Reduce costs. Maximise profitability. You can with CareTrack.

* In markets where CareTrack is available

TAKE A LOOK AROUND.

ECO mode

Volvo's unique, award-winning ECO mode gives more fuel efficiency without any loss of performance.

Work modes

Achieve optimum performance and increased fuel efficiency by selecting the best work mode for the task at hand.

Digging power and speed

Perform at a higher level with increased digging power and faster cycle times for greater productivity.



Controllability

Smart hydraulic system for smooth and highly responsive combined operation and travel by prioritizing oil flow according to requirements.



Fuel efficiency

The Volvo D4 Stage IIIB/ Tier 4 Interim engine together with improved hydraulics deliver up to 14% rise in fuel efficiency and shorter cycle times for increased performance.

A large, black Volvo excavator arm and bucket, shown in a studio setting. The word "VOLVO" is printed in white on the side of the boom. The bucket is at the bottom, and the arm extends upwards and to the right. The background is a plain, light color.

VOLVO

Dozer blade

Increase versatility and stability with a dozer blade.



CareTrack*

Volvo's telematics system guides machine owners towards optimized productivity and their next service – remotely.



Volvo Care Cab

Enjoy all-round visibility, easy to access controls and excellent air ventilation in Volvo's spacious cab which meets ROPS safety standards.

Grouped filters

Grouped, ground level filters in the pump compartment enable faster servicing and more machine uptime.

Rear access

Rear entry behind the cab grants safe and convenient access to the main hydraulic components and engine.

Powerful engine

Volvo's efficient D4 Stage IIIB/ Tier 4 Interim engine gives you more power while consuming less fuel for low emission levels.



Serviceability

Premium serviceability from large, wide opening doors featuring automatic stays and locking devices.

* In markets where CareTrack is available

VOLVO EC160D, EC180D IN DETAIL.

	EC160D	EC180D
--	--------	--------

Engine

The latest generation, Volvo engine Tier 4i (Stage IIIB) emissions compliant diesel engine fully meets the demands of the latest, emissions regulations. The engine uses precise, highpressure fuel injectors, turbo charger and air-to-air intercooler, and electronic engine controls to optimize machine performance.

Air Filter: 3-stage with precleaner.

Automatic Idling System: Reduces engine speed to idle when the levers and pedals are not activated resulting in less fuel consumption and low cab noise levels.

Engine	Volvo	D4H
Max power at	r/s / r/min	33,3 / 2 000
Net, ISO 9249/SAE J1349	kW / hp	104 / 141
Gross, ISO 14396/SAE J1995	kW / hp	105 / 143
Max torque at	Nm / r/min	609 / 1 600
No. of cylinders		4
Displacement	l	4,036
Bore	mm	101
Stroke	mm	126

	EC160D	EC180D
--	--------	--------

Electrical system

High-capacity electrical system that is well protected. Waterproof double-lock harness plugs are used to secure corrosion-free connections. The main relays and solenoid valves are shielded to prevent damage. The master switch is standard.

Contronics provides advanced monitoring of machine functions and important diagnostic information on the I-ECU.

Voltage	V	28
Batteries	V	2 x 12
Battery capacity	Ah	110
Alternator	V / Ah	28 / 110

Swing system

The swing system uses an axial piston motors, driving a planetary gearbox for maximum torque. An automatic holding brake and anti-rebound valve are standard.

Max. slew speed	r/min	12,5
Max. slew torque	kNm	51,7

Drive

Each track is powered by an automatic two-speed shift travel motor. The track brakes are multi-disc, spring-applied and hydraulic released. The travel motor, brake and planetary gears are well protected within the track frame.

Max. drawbar pull	kN	145	159
Max. travel speed	km/h	3,1 / 5,6	2,9 / 5,5
Gradeability	°	35	35

Undercarriage

The undercarriage has a robust X-shaped frame. Greased and sealed track chains are standard.

Track shoe		2 x 44	2 x 46
Link pitch	mm	190	190
Shoe width, triple grouser	mm	500/600/ 700/800/ 900	600/700/ 800/900
Bottom rollers		2 x 7	2 x 7
Top rollers		2 x 2	2 x 2

	EC160D	EC180D
--	--------	--------

Hydraulic system

The hydraulic system, also known as the "Automatic Sensing Work Mode," is designed for high-productivity, high-digging capacity, high-maneuvering precision and excellent fuel economy. The summation system, boom, arm and swing priority along with boom, arm and bucket regeneration provides optimum performance.

The following important functions are included in the system:

Summation system: Combines the flow of both hydraulic pumps to ensure quick cycle times and high productivity.

Boom priority: Gives priority to the boom operation for faster raising when loading or performing deep excavations.

Arm priority: Gives priority to the arm operation for faster cycle times in leveling and for increased bucket filling when digging.

Swing priority: Gives priority to swing functions for faster simultaneous operations.

Regeneration system: Prevents cavitation and provides flow to other movements during simultaneous operations for maximum productivity.

Power boost: All digging and lifting forces are increased.

Holding valves: Boom and arm holding valves prevent the digging equipment from creeping.

Main pump, Type 2 x variable displacement axial piston pumps

Maximum flow	l/min	2 x 152
--------------	-------	---------

Pilot pump, Type Gear pump

Maximum flow	l/min	1 x 20
--------------	-------	--------

Hydraulic motors

Travel: Variable displacement axial piston motor with mechanical brake

Slew: Fixed displacement axial piston motor with mechanical brake

Relief valve setting

Implement	MPa	34,3 / 36,3
-----------	-----	-------------

Travel circuit	MPa	34,3 / 34,3
----------------	-----	-------------

Slew circuit	MPa	26,5 / 26,5
--------------	-----	-------------

Pilot circuit	MPa	3,9 / 3,9
---------------	-----	-----------

Hydraulic cylinders

Mono boom		2
-----------	--	---

Bore x Stroke	ø x mm	115 x 1 165
---------------	--------	-------------

2 piece boom		1
--------------	--	---

Bore x Stroke	ø x mm	160 x 950
---------------	--------	-----------

Arm		1
-----	--	---

Bore x Stroke	ø x mm	120 x 1 345
---------------	--------	-------------

Bucket		1
--------	--	---

Bore x Stroke	ø x mm	105 x 1 000
---------------	--------	-------------

	EC160D	EC180D
--	--------	--------

Service refill capacities

Fuel tank	l	250
-----------	---	-----

Hydraulic system, total	l	255
-------------------------	---	-----

Hydraulic tank	l	111
----------------	---	-----

Engine oil	l	12
------------	---	----

Engine coolant	l	15
----------------	---	----

Swing reduction unit	l	0,4
----------------------	---	-----

Travel reduction unit	l	2 x 5,8
-----------------------	---	---------

Cab

The operator's cab has easy access via a wide door opening. The cab is supported on hydraulic dampening mounts to reduce shock and vibration levels. These along with sound absorbing lining provide low noise levels. The cab has excellent all-round visibility. The front windshield can easily slide up into the ceiling, and the lower front glass can be removed and stored in the side door. Integrated air-conditioning and heating system:

The pressurized and filtered cab air is supplied by an automatically-controlled fan. The air is distributed throughout the cab from 14 vents.

Ergonomic operator's seat: The adjustable seat and joystick console move independently to accommodate the operator. The seat has nine different adjustments plus a seat belt for the operator's comfort and safety.

Sound Level

Sound level in cab according to ISO 6396

LpA (standard)	dB(A)	69
----------------	-------	----

LpA (tropical)	dB(A)	70
----------------	-------	----

External sound level according to ISO 6395 and EU Noise Directive (2000/14/EC) and 474-1:2006 +A1:2009

LwA (standard)	dB(A)	101
----------------	-------	-----

LwA (tropical)	dB(A)	102
----------------	-------	-----

SPECIFICATIONS.

VOLVO BUCKETS

Loose soil, re-handling material or abrasive rock; excavators and attachments work hand in hand to move almost any type of material. Volvo's experience together with excavator and attachment technology ensures a reduction in cycle times, increased productivity and lower fuel costs through higher breakout forces and quicker bucket fill times.

The efficiency of any type of excavation depends upon the selection of the right bucket therefore a broad bucket offering available from the same retailer as your excavator means the machine can be easily adjusted to operate in any conditions.

As the technology and experience in design for both Volvo's attachments and excavators stems from the same origin, availing from another service like Volvo's aftermarket support ensures the machine is running harder for longer.



(GP) General purpose bucket

Designed for digging and re-handling soft to medium materials e.g. soils with low wear characteristics, the GP bucket has anti-abrasive side cutters, a hardened lip plate and self-sharpening bucket teeth.

(HD) Heavy-duty bucket

Intended for digging in dense materials such as hard packed clay and gravel. The HD bucket has heavier overall fabrication with a thicker side cutting edge and hardened plating on all critical ground-engaging areas.

(RK) Rock bucket

Together with harder and thicker plating on all critical leading edges the rock bucket provides digging performance in soils with a high degree of rock content and well blasted rock.

(FD) Fixed ditching bucket

A wide face, round profile and drain holes make the FD bucket ideal for ditch cleaning or removal of other soft material. An inner stiffener and optional bolt-on cutting edge bolster performance.

Volvo quick couplers

Direct fit attachments will always deliver a high performance however with the need for excavators to handle more tasks than ever before, Volvo offer a diverse range of Attachment Quick Couplers providing various levels of versatility and performance to meet every need.

VOLVO TOOTH SYSTEM



Self-Sharpening Tooth System Cuts Through the Toughest Jobs

Volvo perfects the excavator bucket's point of attack with a robust tooth system that delivers performance and long life. Cast and tempered from a high-strength alloy, Volvo teeth resist stress and deliver optimum penetration in hard or abrasive material. An innovative design lessens internal wear between tooth and adapter — and makes it easy to change teeth.

LOCKING DEVICE

Patented vertical locking device. The steel pin with flexible lock retainer tightly secures the tooth to the adapter. Smart design transfers working stresses away from the locking device, saving wear on the steel pin and extending pin life. Self-sharpening Volvo teeth are designed for a small penetration area, which reduces stress and wear at the point of contact.

GPE

Self-sharpening general-purpose tooth with good penetration and long service life.

AMRE / ARXE

Tooth with extra-wear metal and longer service life intended for rock and abrasive material. Self sharpening.

PPE

Pick-point excavator tooth delivers maximum penetration in hard clay or frozen ground.

SNE

Spade nose tooth is designed for finishing work such as leveling, grading, cleaning & backfilling.

TPE

Twin pick point with sharp, dual-point profile is ideal for compact or frozen ground.

Wear Cap & BLW Adapter

Wear cap protects the adapter from unnecessary wear.

BLW: Bottom leg adapter for wear cap with extra long top leg for welding to both sides of the cutting edge. Long bottom leg.

BL: 1 1/2 bottom leg adapter for welding to both sides of the cutting edge

MAXIMUM PERMITTED BUCKETS

EC160DL with 2 750kg counterweight

Boom, Direct Fit	m	5,2			5,0 2-piece		
Arm	m	2,3	2,6	3,0	2,3	2,6	3,0
Max. bucket	t/m ³	liter	liter	liter	liter	liter	liter
GP Bucket	1,5	1 225	1 025	875	1 225	1 025	875
	1,8	1 075	900	775	1 075	900	775
HD Bucket	1,8	975	850	750	975	850	750
	2,0	900	800	700	900	800	700
Boom, Quick Coupler	m	5,2			5,0 2-piece		
Arm	m	2,3	2,6	3,0	2,3	2,6	3,0
Max. bucket	t/m ³	liter	liter	liter	liter	liter	liter
GP Bucket	1,5	1 050	900	775	1 050	900	775
	1,8	925	800	675	925	800	675
HD Bucket	1,8	875	750	650	875	750	650
	2,0	825	700	600	825	700	600

EC160DNL with 2 750kg counterweight

Boom, Direct Fit	m	5,2			5,0 2-piece		
Arm	m	2,3	2,6	3,0	2,3	2,6	3,0
Max. bucket	t/m ³	liter	liter	liter	liter	liter	liter
GP Bucket	1,5	1 125	1 025	875	1 125	1 025	875
	1,8	1 000	900	775	1 000	900	775
HD Bucket	1,8	875	825	750	875	825	750
	2,0	825	775	700	825	775	700
Boom, Quick Coupler	m	5,2			5,0 2-piece		
Arm	m	2,3	2,6	3,0	2,3	2,6	3,0
Max. bucket	t/m ³	liter	liter	liter	liter	liter	liter
GP Bucket	1,5	950	875	775	950	875	775
	1,8	825	775	675	825	775	675
HD Bucket	1,8	800	725	650	800	725	650
	2,0	725	675	600	725	675	600

EC180DL with 3 200kg counterweight

Boom, Direct Fit	m	5,2			5,0 2-piece		
Arm	m	2,3	2,6	3,0	2,3	2,6	3,0
Max. bucket	t/m ³	liter	liter	liter	liter	liter	liter
GP Bucket	1,5	1 225	1 025	875	1 225	1 025	875
	1,8	1 075	900	775	1 075	900	775
HD Bucket	1,8	1 025	875	750	1 025	875	750
	2,0	950	800	700	950	800	700
Boom, Direct Fit	m	5,2			5,0 2-piece		
Arm	m	2,3	2,6	3,0	2,3	2,6	3,0
Max. bucket	t/m ³	liter	liter	liter	liter	liter	liter
GP Bucket	1,5	1 100	925	775	1 100	925	775
	1,8	975	825	675	975	825	675
HD Bucket	1,8	925	775	650	925	775	650
	2,0	875	725	600	875	725	600

- Note: 1. Bucket size based on ISO 7451, heaped material with a 1:1 angle of repose
 2. "Max. permitted sizes" are for reference only and are not necessarily available from the factory
 3. Bucket widths are less than bucket's tip radius.

SPECIFICATIONS.

MACHINE WEIGHTS AND GROUND PRESSURE

Description Units	Shoe width mm	Operating weight kg	Ground pressure kPa	Overall width mm	Shoe width mm	Operating weight kg	Ground pressure kPa	Overall width mm
EC160DL	5,2m boom 2,6m arm 470kg bucket 2 750kg counterweight				5,0m 2 piece boom 2,6m arm 470kg bucket 2 750kg counterweight			
Triple grouser	500	16 930	48,0	2 700	500	17 350	49,0	2 700
	600	17 160	40,2	2 800	600	17 580	41,2	2 800
	700	17 400	35,3	2 900	700	17 820	36,3	2 900
	800	17 800	31,4	3 000	800	18 210	32,4	3 000
	900	18 060	28,4	3 100	900	18 480	29,4	3 100
EC160DL with Dozer Blade	5,2m boom 2,6m arm 470kg bucket 2 750kg counterweight				5,0m 2 piece boom 2,6m arm 470kg bucket 2 750kg counterweight			
Triple grouser	500	18 110	51,0	2 700	500	18 530	53,0	2 700
	600	18 340	43,1	2 800	600	18 760	44,1	2 800
	700	18 580	37,3	2 900	700	19 000	38,2	2 900
	800	18 980	33,3	3 000	800	19 390	34,3	3 000
	900	19 240	30,4	3 100	900	19 660	31,4	3 100
EC160DNL	5,2m boom 2,6m arm 470kg bucket 2 750kg counterweight				5,0m 2 piece boom 2,6m arm 470kg bucket 2 750kg counterweight			
Triple grouser	500	16 840	48,0	2 490	500	17 090	48,0	2 490
	600	17 070	40,2	2 590	600	17 320	41,2	2 590
	700	17 300	35,3	2 690	700	17 550	35,3	2 690
	800	17 700	31,4	2 790	800	17 950	31,4	2 790
	900	17 970	28,4	2 890	900	18 220	28,4	2 890
EC160DNL with Dozer Blade	5,2m boom 2,6m arm 470kg bucket 2 750kg counterweight				5,0m 2 piece boom 2,6m arm 470kg bucket 2 750kg counterweight			
Triple grouser	500	18 000	51,0	2 490	500	18 420	52,0	2 490
	600	18 230	43,1	2 590	600	18 650	44,1	2 590
	700	18 460	37,3	2 690	700	18 880	38,2	2 690
	800	18 860	33,3	2 790	800	19 280	34,3	2 790
	900	19 130	30,4	2 890	900	19 540	30,4	2 890
EC180DL	5,2m boom 2,6m arm 470kg bucket 3 200kg counterweight				5,2m 2 piece boom 2,6m arm 470kg bucket 3 200kg counterweight			
Triple grouser	600	18 300	40,2	2 800	600	18 720	41,2	2 800
	700	18 720	35,3	2 900	700	19 140	36,3	2 900
	800	19 000	31,4	3 000	800	19 420	32,4	3 000
	900	19 250	28,4	3 100	900	19 710	29,4	3 100

DIMENSIONS

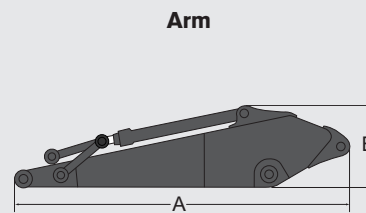
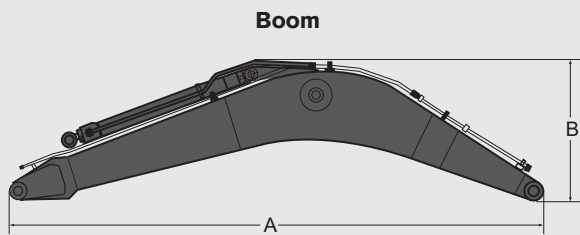

EC160D								
Description	Unit	mono	2-piece	Description	Unit	2,3	2,6	3,0
Boom	m	5,2	5,0	Arm	m	2,3	2,6	3,0
Length (A)	mm	5 400	5 200	Length (A)	mm	3 240	3 500	3 900
Height (B)	mm	1 640	1 270	Height (B)	mm	855	855	845
Width	mm	565	565	Width	mm	395	395	395
Weight	kg	1 370	1 610	Weight	kg	790	800	860
EC180D								
Description	Unit	mono	2-piece	Description	Unit	2,3	2,6	3,0
Boom	m	5,2	5,0	Arm	m	2,3	2,6	3,0
Length (A)	mm	5 400	5 200	Length (A)	mm	3 240	3 500	3 900
Height (B)	mm	1 640	1 270	Height (B)	mm	855	855	845
Width	mm	565	565	Width	mm	395	395	395
Weight	kg	1 370	1 610	Weight	kg	790	800	860

* Includes cylinder, piping and pin, excludes boom cyl. Pin

* Includes cylinder, linkage and pin

DIMENSIONS

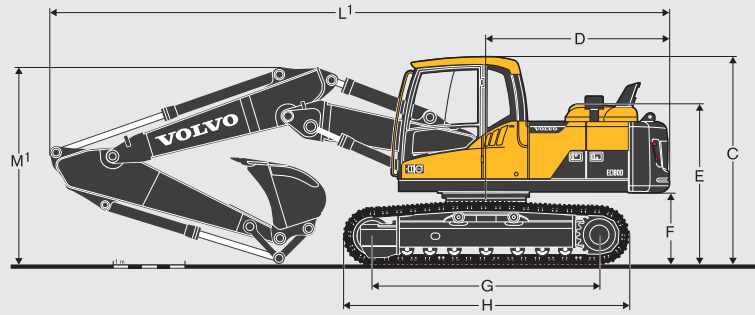
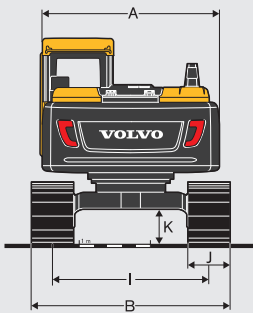

Description	Unit	EC160DL			EC160DNL		
		5,2 mono or 5,0 2 piece			5,2 mono or 5,0 2 piece		
Boom	m	2,3	2,6	3,0	2,3	2,6	3,0
A Overall width of upper structure	mm	2 490	2 490	2 490	2 490	2 490	2 490
B Overall width	mm	2 800	2 800	2 800	2 590	2 590	2 590
C Overall height of cab	mm	2 900	2 900	2 900	2 900	2 900	2 900
D Tail slew radius	mm	2 550	2 550	2 550	2 550	2 550	2 550
E Overall height of engine hood	mm	2 235	2 235	2 235	2 235	2 235	2 235
F Counterweight clearance *	mm	1 010	1 010	1 010	1 010	1 010	1 010
G Tumbler length	mm	3 180	3 180	3 180	3 180	3 180	3 180
H Track length	mm	3 972	3 972	3 972	3 972	3 972	3 972
I Track gauge	mm	2 200	2 200	2 200	1 990	1 990	1 990
J Shoe width	mm	600	600	600	600	600	600
K Min. ground clearance *	mm	460	460	460	460	460	460
L Overall length	mm	8 780	8 670	8 710	8 780	8 670	8 710
L ¹ Overall length	mm	8 600	8 520	8 520	8 600	8 520	8 520
M Overall height of boom	mm	2 980	2 900	3 020	2 980	2 900	3 020
M ¹ Overall height of boom	mm	2 770	2 770	2 930	2 770	2 770	2 930

* Without shoe grouser / ¹ 2-piece boom

		EC160DL	EC160DNL
A Height	m	503	510
Width	mm	2 800	2 590
Weight	kg	595	575
B Lift height	mm	607	607
C Digging depth	mm	708	710

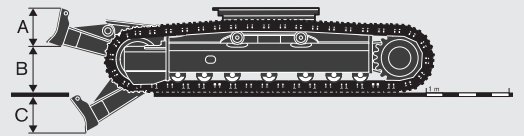

Description	Unit	EC180DL		
		5,2 mono or 5,0 2 piece		
Boom	m	2,3	2,6	3,0
A Overall width of upper structure	mm	2 490	2 490	2 490
B Overall width	mm	2 800	2 800	2 800
C Overall height of cab	mm	2 930	2 930	2 930
D Tail slew radius	mm	2 550	2 550	2 550
E Overall height of engine hood	mm	2 265	2 265	2 265
F Counterweight clearance *	mm	1 040	1 040	1 040
G Tumbler length	mm	3 370	3 370	3 370
H Track length	mm	4 166	4 166	4 166
I Track gauge	mm	2 200	2 200	2 200
J Shoe width	mm	600	600	600
K Min. ground clearance *	mm	460	460	460
L Overall length	mm	8 780	8 670	8 710
L ¹ Overall length	mm	8 600	8 520	8 520
M Overall height of boom	mm	3 010	2 930	3 050
M ¹ Overall height of boom	mm	2 800	2 800	2 960

* Without shoe grouser / ¹ 2-piece boom

SPECIFICATIONS.

WORKING RANGES

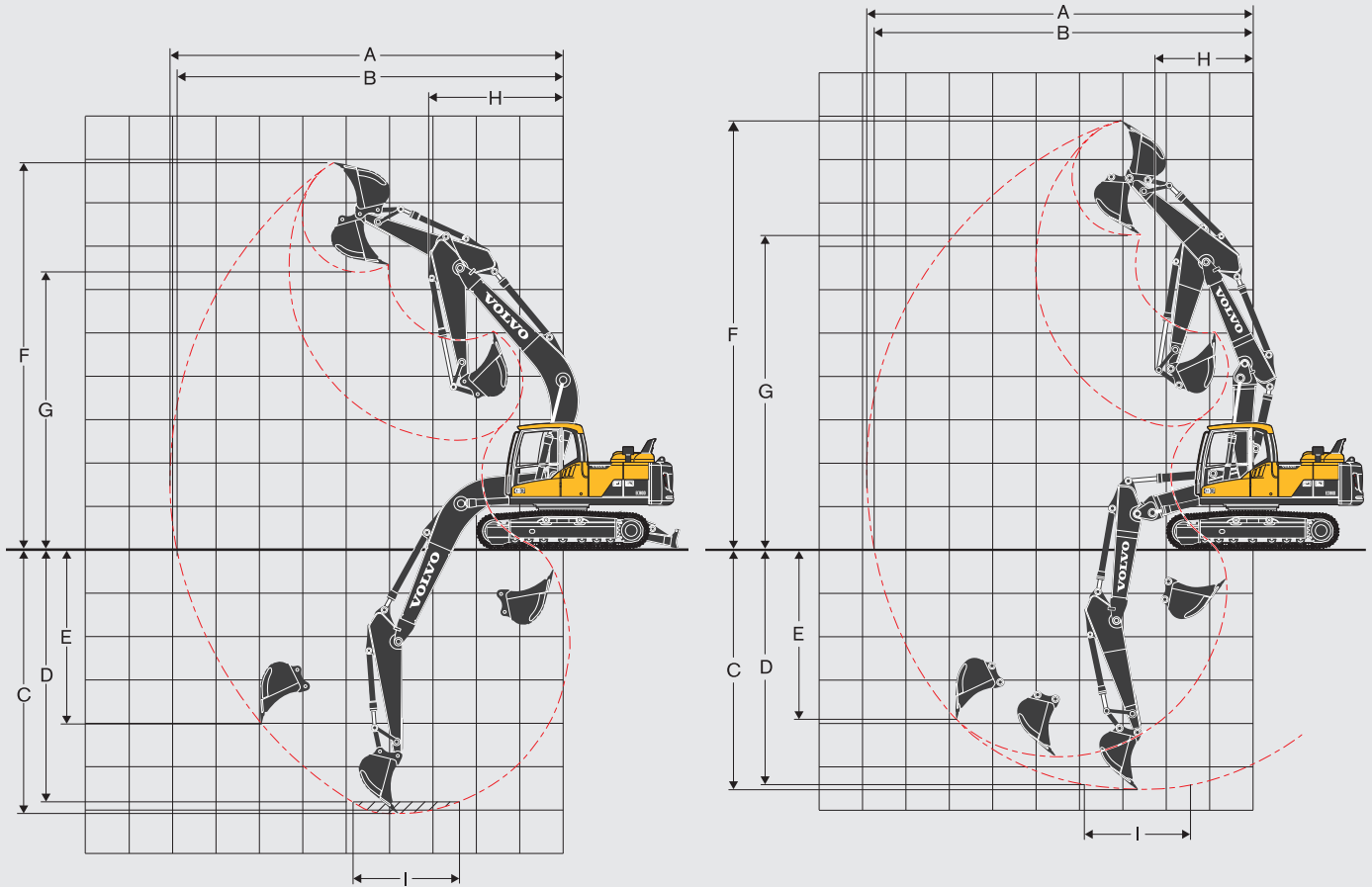

Description	Unit	EC160DL and EC160DNL						EC180DL					
Boom	m	5,2 mono			5,0 2-piece			5,2 mono			5,0 2-piece		
Arm	m	2,3	2,6	3,0	2,3	2,6	3,0	2,3	2,6	3,0	2,3	2,6	3,0
A Max. digging reach	mm	8 650	8 970	9 340	8 550	8 870	9 240	8 650	8 970	9 340	8 550	8 870	9 240
B Max. digging reach on ground	mm	8 490	8 810	9 180	8 380	8 700	9 090	8 480	8 800	9 180	8 370	8 690	9 080
C Max. digging depth	mm	5 740	6 040	6 440	5 210	5 530	5 930	5 700	6 000	6 400	5 180	5 500	5 890
D Max. digging depth (l = 2440 mm level)	mm	5 420	5 770	6 200	5 090	5 410	5 810	5 390	5 740	6 170	5 060	5 380	5 780
E Max. vertical wall digging depth	mm	4 480	4 950	5 380	4 270	4 630	5 040	4 440	4 920	5 340	4 240	4 600	5 010
F Max. cutting height	mm	8 570	8 820	9 030	9 530	9 830	10 140	8 600	8 850	9 070	9 560	9 860	10 170
G Max. dumping height	mm	6 110	6 340	6 540	6 920	7 210	7 520	6 140	6 370	6 580	6 950	7 240	7 550
H Min. front swing radius	mm	3 070	3 070	3 070	2 290	2 250	2 350	3 070	3 070	3 060	2 320	2 250	2 390
Digging forces with direct fit bucket													
Bucket radius	mm	1 315	1 315	1 315	1 315	1 315	1 315	1 315	1 315	1 315	1 315	1 315	1 315
Breakout force - bucket	Normal	SAE J1179	kN	101,9	101,9	101,9	101,9	101,9	101,9	101,9	101,9	101,9	101,9
	Power boost	SAE J1179	kN	107,7	107,7	107,7	107,7	107,7	107,7	107,7	107,7	107,7	107,7
	Normal	ISO 6015	kN	114,7	114,7	114,7	114,7	114,7	114,7	114,7	114,7	114,7	114,7
	Power boost	ISO 6015	kN	121,3	121,3	121,3	121,3	121,3	121,3	121,3	121,3	121,3	121,3
Tearout force - dipper arm	Normal	SAE J1179	kN	90,4	80,4	72,8	90,4	80,4	72,8	90,4	80,4	72,8	90,4
	Power boost	SAE J1179	kN	95,5	85	76,9	95,5	85	76,9	95,5	85	76,9	95,5
	Normal	ISO 6015	kN	92,9	82,3	74,3	92,9	82,3	74,3	92,9	82,3	74,3	92,9
	Power boost	ISO 6015	kN	98,2	87	78,6	98,2	87	78,6	98,2	87	78,6	98,2
Rotation angle, bucket	°	183	183	183	183	183	183	183	183	183	183	183	183

Lifting capacity at the arm end without bucket.

For lifting capacity including bucket, simply subtract actual weight of the direct fit bucket or the bucket with quick coupler from the following values.

Lifting hook related to ground level		Along	Across	Along	Across	Along	Across	Along	Across	Along	Across	Along	Across	Max. m		
		undercarriage 1,5 m	undercarriage 1,5 m	undercarriage 3,0 m	undercarriage 3,0 m	undercarriage 4,5 m	undercarriage 4,5 m	undercarriage 6,0 m	undercarriage 6,0 m	undercarriage 7,5 m	undercarriage 7,5 m	undercarriage Max. reach	undercarriage Max. reach			
LIFTING CAPACITY EC160DL																
Boom 5,2m	6,0 m kg													*4 470	3 750	5,9
Arm 2,3m	4,5 m kg					*4 950	*4 950	*4 650	3 580					4 220	2 950	6,8
Shoe 600mm	3,0 m kg					*6 560	5 250	4 990	3 450					3 740	2 590	7,2
CWT 2 750kg	1,5 m kg					7 470	4 930	4 830	3 300					3 570	2 460	7,3
	0 m kg					7 270	4 750	4 720	3 200					3 670	2 510	7,1
	-1,5 m kg			*10 820	8 930	7 230	4 710	4 680	3 170					4 090	2 780	6,6
	-3,0 m kg			*12 990	9 070	7 300	4 780							5 250	3 540	5,6
Boom 5,2m	7,5 m kg													*4 100	*4 100	4,8
Arm 2,6m	6,0 m kg									*4 140	3 690			*3 830	3 430	6,3
Shoe 600mm	4,5 m kg					*4 560	*4 560	*4 370	3 630					*3 760	2 750	7,1
CWT 2 750kg	3,0 m kg			*9 710	*9 710	*6 180	5 320	5 000	3 470					3 530	2 440	7,5
	1,5 m kg					7 500	4 960	4 850	3 300	3 550	2 460			3 380	2 320	7,7
	0 m kg			*5 610	*5 610	7 270	4 750	4 710	3 190					3 440	2 360	7,5
	-1,5 m kg	*5 780	*5 780	*9 900	8 860	7 190	4 690	4 650	3 140					3 790	2 580	6,9
	-3,0 m kg	*10 320	*10 320	*13 450	9 000	7 240	4 730							4 700	3 190	6,0
	-4,5 m kg			*10 810	9 300									*7 440	5 180	4,4
Boom 5,2m	7,5 m kg													*3 470	*3 470	5,4
Arm 3,0m	6,0 m kg									*3 650	*3 650			*3 160	3 050	6,7
Shoe 600mm	4,5 m kg									*3 970	3 630			*3 100	2 510	7,5
CWT 2 750kg	3,0 m kg													*3 190	2 240	7,9
	1,5 m kg			*8 180	*8 180	*5 590	5 360	*4 710	3 470	3 550	2 460			3 110	2 130	8,0
	0 m kg			*5 650	*5 650	*7 420	4 980	4 830	3 300	3 450	2 380			3 170	2 160	7,8
	-1,5 m kg	*5 290	*5 290	*6 120	*6 120	7 240	4 720	4 680	3 160	3 390	2 310			3 450	2 340	7,3
	-3,0 m kg	*8 980	*8 980	*13 870	8 840	7 150	4 640	4 620	3 110					4 160	2 810	6,5
	-4,5 m kg			*11 760	9 100	7 320	4 790							6 240	4 150	5,0
Boom 5,0m 2-piece	7,5 m kg													*5 560	*5 560	4,1
Arm 2,3m	6,0 m kg													*4 800	3 840	5,7
Shoe 600mm	4,5 m kg					*7 740	*7 740	*7 430	5 590	5 110	3 530			4 320	2 990	6,6
CWT 2 750kg	3,0 m kg							7 850	5 230	4 970	3 400			3 810	2 620	7,1
	1,5 m kg							7 450	4 880	4 810	3 250			3 650	2 490	7,2
	0 m kg							7 240	4 690	4 700	3 140			3 750	2 550	7,0
	-1,5 m kg							7 210	4 660	4 680	3 130			4 220	2 850	6,5
	-3,0 m kg			*10 820	8 840			*5 780	4 760							5,4
Boom 5,0m 2-piece	7,5 m kg							*4 790	*4 790					*4 340	*4 340	4,7
Arm 2,6m	6,0 m kg							*5 540	*5 540	*4 200	3 610			*3 790	3 470	6,1
Shoe 600mm	4,5 m kg					*5 860	*5 860	*6 350	5 660	5 150	3 570			*3 640	2 770	7,0
CWT 2 750kg	3,0 m kg			*12 590	10 020	7 930	5 300	4 990	3 430					3 570	2 450	7,4
	1,5 m kg							7 510	4 930	4 820	3 270			3 420	2 330	7,5
	0 m kg			*6 190	*6 190	7 250	4 700	4 690	3 150	3 450	2 380			3 510	2 380	7,4
	-1,5 m kg			*10 630	8 790	7 180	4 640	4 650	3 110					3 880	2 630	6,8
	-3,0 m kg					*6 410	4 720							*4 270	3 290	5,9
Boom 5,0m 2-piece	7,5 m kg							*4 640	*4 640					*3 520	*3 520	5,3
Arm 3,0m	6,0 m kg							*4 670	*4 670	*4 330	3 670			*3 120	3 090	6,6
Shoe 600mm	4,5 m kg							*5 130	*5 130	*5 090	3 600			*3 010	2 520	7,4
CWT 2 750kg	3,0 m kg			*11 510	10 320	*7 820	5 360	5 010	3 440					*3 060	2 240	7,8
	1,5 m kg			*6 950	*6 950	*7 540	4 950	4 810	3 260	3 430	2 330			3 150	2 140	7,9
	0 m kg			*6 650	*6 650	7 230	4 680	4 660	3 120	3 360	2 270			3 210	2 170	7,7
	-1,5 m kg			*9 910	8 660	7 120	4 580	4 590	3 050					3 520	2 370	7,2
	-3,0 m kg			*9 570	8 800	*7 060	4 620	4 630	3 090					*4 240	2 880	6,3
Boom 5,2m	6,0 m kg													*4 470	4 220	5,9
Arm 2,3m	4,5 m kg					*4 950	*4 950	*4 650	4 100					*4 670	3 360	6,8
Shoe 600mm	3,0 m kg					*6 560	5 800	*5 310	3 960					*4 880	2 980	7,2
CWT 2 750kg	1,5 m kg					*8 230	5 720	*6 110	3 810					*5 300	2 840	7,3
Dozer Blade Down	0 m kg							*9 240	5 540	*6 730	3 710			*5 710	2 910	7,1
	-1,5 m kg							*9 480	5 500	*6 940	3 680			*6 240	3 220	6,6
	-3,0 m kg			*10 820	10 140	*12 990	10 730	*8 890	5 570					*6 950	4 060	5,6
Boom 5,2m	7,5 m kg													*4 100	*4 100	4,8
Arm 2,6m	6,0 m kg									*4 140	4 020			*3 830	*3 830	6,3
Shoe 600mm	4,5 m kg					*4 560	*4 560	*4 370	4 120					*3 760	3 170	7,1
CWT 2 750kg	3,0 m kg			*9 710	*9 710	*6 180	5 870	*5 080	3 990					*3 880	2 820	7,5
Dozer Blade Down	1,5 m kg					*7 920	5 750	*5 920	3 820	*3 980	2 840			*4 210	2 690	7,7
	0 m kg			*5 610	*5 610	*9 080	5 520	*6 610	3 690					*4 820	2 730	7,5
	-1,5 m kg	*5 780	*5 780	*9 900	*9 900	*9 480	5 440	*6 930	3 630					*5 900	2 990	6,9
	-3,0 m kg	*10 320	*10 320	*13 450	10 230	*9 090	5 480							*6 540	3 680	6,0
	-4,5 m kg			*10 810	10 550									*7 440	5 970	4,4
Boom 5,2m	7,5 m kg													*3 540	*3 540	5,4
Arm 3,0m	6,0 m kg									*3 650	*3 650			*3 230	*3 230	6,7
Shoe 600mm	4,5 m kg									*3 970	*3 970			*3 170	2 890	7,5
CWT 2 750kg	3,0 m kg					*8 180	*8 180	*5 590	5 590	*4 710	3 980	*4 390	2 830	*3 260	2 600	7,9
Dozer Blade Down	1,5 m kg			*5 650	*5 650	*7 420	5 760	*5 610	3 810	*4 820	2 730			*3 510	2 490	8,0
	0 m kg			*6 120	*6 120	*8 760	5 510	*6 380	3 670	*5 220	2 690			*3 970	2 530	7,8
	-1,5 m kg	*5 290	*5 290	*9 270	*9 270	*9 360	5 410	*6 820	3 600					*4 830	2 740	7,3
	-3,0 m kg	*8 980	*8 980	*13 870	10 480	*9 210	5 430	*6 700	3 620					*6 090	3 280	6,5
	-4,5 m kg			*11 760	10 750	*7 890	5 580							*6 930	4 830	5,0
Boom 5,0m 2-piece	7,5 m kg													*5 560	*5 560	4,1
Arm 2,3m	6,0 m kg													*4 800	4 400	5,7
Shoe 600mm	4,5 m kg					*7 860	*7 860	*7 430	6 390	*6 250	4 060			*4 640	3 440	6,6
CWT 2 750kg	3,0 m kg							*8 520	6 030	*6 610	3 920			*4 760	3 030	7,1
Dozer Blade Down	1,5 m kg							*9 370	5 570	*6 910	3 770			*5 150	2 890	7,2
	0 m kg							*9 310	5 480	*6 800	3 670			*5 470	2 960	7,0
	-1,5 m kg							*8 200	5 450	*5 920	3 650			*5 150	3 310	6,5
	-3,0 m kg							*5 780	5 340							5,4

Notes: 1. Machine in "Fine Mode-F" (Power Boost) for lifting capacities. 2. The above loads are in compliance with SAE J1097 and ISO 10567 Hydraulic Excavator Lifting Capacity Standards. 3

SPECIFICATIONS.

Lifting capacity at the arm end without bucket.

For lifting capacity including bucket, simply subtract actual weight of the direct fit bucket or the bucket with quick coupler from the following values.

Lifting hook related to ground level	Along		Across		Along		Across		Along		Across		Along		Across		Max. m
	Along	Across	Along	Across	Along	Across	Along	Across	Along	Across	Along	Across	Along	Across	Along	Across	
	undercarriage 1,5 m		undercarriage 3,0 m		undercarriage 4,5 m		undercarriage 6,0 m		undercarriage 7,5 m		undercarriage Max. reach						
LIFTING CAPACITY EC160DL																	
Boom 5,0m 2-piece	7,5 m	kg					*4 790	*4 790							*4 340	*4 340	4,7
Arm 2,6m	6,0 m	kg					*5 540	*5 540	*4 280	4 140					*3 790	*3 790	6,1
Shoe 600mm	4,5 m	kg					*6 350	6 350	*5 740	4 090					*3 650	3 190	7,0
CWT 2 750kg	3,0 m	kg			*5 770	*5 770	*8 250	6 090	*6 460	3 950					*3 700	2 840	7,4
Dozer Blade Down	1,5 m	kg					*9 240	5 710	*6 840	3 780			*4 290	2 740	*3 950	2 710	7,5
	0 m	kg					*9 390	5 490	*6 860	3 660					*4 450	2 770	7,4
	-1,5 m	kg			*6 190	*6 190	*8 510	5 420	*6 180	3 620					*4 950	3 060	6,8
	-3,0 m	kg			*10 630	9 670	*6 410	5 500							*4 270	3 820	5,9
Boom 5,0m 2-piece	7,5 m	kg					*4 640	*4 640							*3 590	*3 590	5,3
Arm 3,0m	6,0 m	kg					*4 670	*4 580	*4 330	4 190					*3 190	*3 190	6,6
Shoe 600mm	4,5 m	kg					*5 130	*5 130	*5 090	4 120					*3 080	2 910	7,4
CWT 2 750kg	3,0 m	kg			*11 510	*11 510	*7 820	6 150	*6 210	3 960			*4 260	2 790	*3 120	2 610	7,8
Dozer Blade Down	1,5 m	kg					*8 970	5 740	*6 680	3 770			*5 050	2 720	*3 300	2 500	7,9
	0 m	kg			*6 950	*6 950	*9 380	5 460	*6 840	3 630			*5 050	2 650	*3 680	2 540	7,7
	-1,5 m	kg			*9 910	9 890	*8 780	5 360	*6 400	3 550					*4 390	2 770	7,2
	-3,0 m	kg			*9 570	*9 570	*7 060	5 400	*4 860	3 610					*4 240	3 360	6,35
LIFTING CAPACITY EC160DNL																	
Boom 5,2m	6,0 m	kg													*4 470	3 340	5,9
Arm 2,3m	4,5 m	kg							*4 950	*4 950	*4 650	3 180			4 150	2 620	6,8
Shoe 500mm	3,0 m	kg							*6 560	4 620	4 890	3 040			3 670	2 290	7,2
CWT 2 750kg	1,5 m	kg							7 320	4 320	4 730	2 910			3 510	2 170	7,3
	0 m	kg							7 120	4 150	4 620	2 810			3 600	2 210	7,1
	-1,5 m	kg							*10 820	7 610	7 080	4 120			4 020	2 450	6,6
	-3,0 m	kg							*12 990	7 750	7 160	4 180			5 150	3 110	5,6
Boom 5,2m	7,5 m	kg													*4 100	*4 100	4,8
Arm 2,6m	6,0 m	kg													*3 750	3 040	6,3
Shoe 500mm	4,5 m	kg							*4 560	*4 560	*4 370	3 210			*3 670	2 440	7,1
CWT 2 750kg	3,0 m	kg							*6 180	4 690	4 920	3 070			3 450	2 160	7,5
	1,5 m	kg							7 380	4 350	4 750	2 920			3 310	2 050	7,7
	0 m	kg							7 140	4 150	4 620	2 810			3 380	2 080	7,5
	-1,5 m	kg			*5 780	*5 780			*9 900	7 560	7 070	4 080			3 720	2 280	6,9
	-3,0 m	kg			*10 320	*10 320			*13 450	7 690	7 120	4 130			4 620	2 810	6,0
	-4,5 m	kg							*10 810	7 980					*7 440	4 550	4,4
Boom 5,2m	7,5 m	kg													*3 610	*3 610	5,4
Arm 3,0m	6,0 m	kg													*3 160	2 790	6,7
Shoe 500mm	4,5 m	kg									*3 970	3 290			*3 250	2 290	7,5
CWT 2 750kg	3,0 m	kg									*4 710	3 140			3 250	2 050	7,9
	1,5 m	kg									4 800	2 970			3 130	1 950	8,0
	0 m	kg									4 650	2 770			3 180	1 970	7,8
	-1,5 m	kg									4 570	2 770			3 460	2 130	7,3
	-3,0 m	kg			*5 290	*5 290			*9 270	7 470	7 050	4 080			4 150	2 540	6,5
	-4,5 m	kg			*8 980	*8 980			*13 870	7 570	7 070	4 100			6 210	3 710	5,0
	-4,5 m	kg							*11 760	7 820	7 240	4 250			*7 440	4 550	4,4
Boom 5,0m 2-piece	7,5 m	kg													*5 460	*5 460	4,1
Arm 2,3m	6,0 m	kg													*4 710	3 410	5,7
Shoe 500mm	4,5 m	kg													4 240	2 640	6,6
CWT 2 750kg	3,0 m	kg													3 730	2 300	7,1
	1,5 m	kg													3 570	2 170	7,2
	0 m	kg													3 670	2 220	7,0
	-1,5 m	kg													4 130	2 490	6,5
	-3,0 m	kg															5,4
Boom 5,0m 2-piece	7,5 m	kg													*4 340	*4 340	4,7
Arm 2,6m	6,0 m	kg													*3 790	3 690	6,1
Shoe 500mm	4,5 m	kg													*3 650	2 960	7,0
CWT 2 750kg	3,0 m	kg													*3 700	2 630	7,4
	1,5 m	kg													*3 950	2 510	7,5
	0 m	kg													*4 460	2 560	7,4
	-1,5 m	kg													*4 630	2 830	6,8
	-3,0 m	kg													*4 270	3 530	5,9
Boom 5,0m 2-piece	7,5 m	kg													*3 620	*3 620	5,3
Arm 3,0m	6,0 m	kg													*3 230	*3 230	6,6
Shoe 500mm	4,5 m	kg													*3 110	2 710	7,4
CWT 2 750kg	3,0 m	kg													*3 160	2 340	7,8
	1,5 m	kg													*3 350	2 320	7,9
	0 m	kg													*3 730	2 360	7,7
	-1,5 m	kg													*4 440	2 570	7,2
	-3,0 m	kg													4 220	3 110	6,3
Boom 5,2m	6,0 m	kg													*4 470	3 910	5,9
Arm 2,3m	4,5 m	kg													*4 670	3 110	6,8
Shoe 500mm	3,0 m	kg													*4 880	2 750	7,2
CWT 2 750kg	1,5 m	kg													*5 300	2 620	7,3
Dozer Blade Down	0 m	kg													*5 710	2 680	7,1
	-1,5 m	kg													*6 240	2 970	6,6
	-3,0 m	kg													*6 950	3 750	5,6
Boom 5,2m	7,5 m	kg													*4 100	*4 100	4,8
Arm 2,6m	6,0 m	kg													*3 750	3 620	6,3
Shoe 500mm	4,5 m	kg													*3 760	2 940	7,1
CWT 2 750kg	3,0 m	kg													*3 880	2 620	7,5
Dozer Blade Down	1,5 m	kg													*4 210	2 500	7,7
	0 m	kg													*4 820	2 540	7,5
	-1,5 m	kg													*5 900	2 790	6,9
	-3,0 m	kg													*6 540	3 420	6,0
	-4,5 m	kg													*7 440	5 530	4,4

Notes: 1. Machine in "Fine Mode-F" (Power Boost) for lifting capacities. 2. The above loads are in compliance with SAE J1097 and ISO 10567 Hydraulic Excavator Lifting Capacity Standards. 3. Rated loads do not exceed 87% of hydraulic lifting capacity or 75% of tipping load. 4. Rated loads marked with an asterisk (*) are limited by hydraulic capacity rather than tipping load.

Lifting capacity at the arm end without bucket.

For lifting capacity including bucket, simply subtract actual weight of the direct fit bucket or the bucket with quick coupler from the following values.

Lifting hook related to ground level		Along		Across		Along		Across		Along		Across		Along		Across		Max. m	
		undercarriage	1,5 m	undercarriage	3,0 m	undercarriage	4,5 m	undercarriage	6,0 m	undercarriage	7,5 m	undercarriage	Max. reach	Max. reach					
LIFTING CAPACITY EC160DNL																			
Boom 5,2m	7,5 m kg																		5,4
Arm 3,0m	6,0 m kg																		6,7
Shoe 500mm	4,5 m kg																		7,5
CWT 2 750kg	3,0 m kg																		7,9
Dozer Blade Down	1,5 m kg																		8,0
	0 m kg																		7,8
	-1,5 m kg	*5 290	*5 290	*8 180	*8 180	*5 590	*5 290	*4 710	*3 720	*4 390	2 650	*3 330	2 440	*3 580	2 330				7,3
	-3,0 m kg	*8 980	*8 980	*13 870	9 410	*9 210	4 970	*6 700	3 350			*6 090	3 050						6,5
	-4,5 m kg			*11 760	9 690	*7 890	5 130					*6 930	4 470						5,0
Boom 5,0m 2-piece	7,5 m kg																		4,1
Arm 2,3m	6,0 m kg																		5,7
Shoe 500mm	4,5 m kg																		6,6
CWT 2 750kg	3,0 m kg																		7,1
Dozer Blade Down	1,5 m kg																		7,2
	0 m kg																		7,0
	-1,5 m kg																		6,5
	-3,0 m kg																		5,4
Boom 5,0m 2-piece	7,5 m kg																		4,7
Arm 2,6m	6,0 m kg																		6,1
Shoe 500mm	4,5 m kg																		7,0
CWT 2 750kg	3,0 m kg																		7,4
Dozer Blade Down	1,5 m kg																		7,5
	0 m kg																		7,4
	-1,5 m kg																		6,8
	-3,0 m kg																		5,9
Boom 5,0m 2-piece	7,5 m kg																		5,3
Arm 3,0m	6,0 m kg																		6,6
Shoe 500mm	4,5 m kg																		7,4
CWT 2 750kg	3,0 m kg																		7,8
Dozer Blade Down	1,5 m kg																		7,9
	0 m kg																		7,7
	-1,5 m kg																		7,2
	-3,0 m kg																		6,3
LIFTING CAPACITY EC180DL																			
Boom 5,2m	6,0 m kg																		5,9
Arm 2,3m	4,5 m kg																		6,8
Shoe 600mm	3,0 m kg																		7,2
CWT 3 200kg	1,5 m kg																		7,3
	0 m kg																		7,1
	-1,5 m kg																		6,6
	-3,0 m kg																		5,6
Boom 5,2m	7,5 m kg																		4,9
Arm 2,6m	6,0 m kg																		6,3
Shoe 600mm	4,5 m kg																		7,1
CWT 3 200kg	3,0 m kg																		7,5
	1,5 m kg																		7,7
	0 m kg																		7,5
	-1,5 m kg	*5 880	*5 880	*10 010	9 830	8 600	5 210	5 510	3 520										6,9
	-3,0 m kg	*10 430	*10 430	*13 410	9 970	8 660	5 270												6,0
	-4,5 m kg			*10 710	10 270														4,3
Boom 5,2m	7,5 m kg																		5,5
Arm 3,0m	6,0 m kg																		6,7
Shoe 600mm	4,5 m kg																		7,5
CWT 3 200kg	3,0 m kg																		7,9
	1,5 m kg																		8,0
	0 m kg																		7,8
	-1,5 m kg	*5 360	*5 360	*9 360	*9 360	8 540	5 150	5 460	3 440										7,3
	-3,0 m kg	*9 070	*9 070	*13 840	9 800	8 560	5 170	5 480	3 460										6,4
	-4,5 m kg			*11 690	10 070	*7 830	5 320												4,9
Boom 5,0m 2-piece	7,5 m kg																		4,2
Arm 2,3m	6,0 m kg																		5,8
Shoe 600mm	4,5 m kg																		6,7
CWT 3 200kg	3,0 m kg																		7,1
	1,5 m kg																		7,2
	0 m kg																		7,0
	-1,5 m kg																		6,5
	-3,0 m kg																		5,4
Boom 5,0m 2-piece	7,5 m kg																		4,7
Arm 2,6m	6,0 m kg																		6,2
Shoe 600mm	4,5 m kg																		7,0
CWT 3 200kg	3,0 m kg																		7,4
	1,5 m kg																		7,5
	0 m kg																		7,3
	-1,5 m kg																		6,8
	-3,0 m kg																		5,8
Boom 5,0m 2-piece	7,5 m kg																		5,3
Arm 3,0m	6,0 m kg																		6,6
Shoe 600mm	4,5 m kg																		7,4
CWT 3 200kg	3,0 m kg																		7,8
	1,5 m kg																		7,9
	0 m kg																		7,7
	-1,5 m kg																		7,2
	-3,0 m kg																		6,3

Notes: 1. Machine in "Fine Mode-F" (Power Boost) for lifting capacities. 2. The above loads are in compliance with SAE J1097 and ISO 10567 Hydraulic Excavator Lifting Capacity Standards. 3. Rated loads do not exceed 87% of hydraulic lifting capacity or 75% of tipping load. 4. Rated loads marked with an asterisk (*) are limited by hydraulic capacity rather than tipping load.

EQUIPMENT.

STANDARD EQUIPMENT

	EC160D	EC180D
Engine		
Turbocharged, 4 stroke diesel engine with water cooling, direct injection and charged air cooler that meets Tier 4i EU (Stage IIIB) requirements	•	•
Air filter with indicator	•	•
Air intake heater	•	•
Cyclone pre-cleaner	•	•
Electric engine shut-off	•	•
Fuel filter and water separator	•	•
Fuel filler pump, 35 lpm	•	•
Alternator, 110 A	•	•
Standard cooling system by fan clutch (40 deg. C)	•	•
Electric/Electronic control system		
Contronics		
Advanced mode control system	•	•
Self-diagnostic system	•	•
Machine status indication	•	•
Engine speed sensing power control	•	•
Automatic idling system	•	•
One-touch power boost	•	•
Safety stop/start function	•	•
Adjustable LCD color monitor	•	•
Master electrical disconnect switch	•	•
Engine restart prevention circuit	•	•
High-capacity halogen lights:		
Frame-mounted 2	•	•
Boom-mounted 2	•	•
Batteries, 2 x 12 V / 110 Ah	•	•
Start motor, 24 V / 5,5 kW	•	•
Caretrack GSM/GPS	•	•
3yr-Caretrack subscription_GSM	•	•
Hydraulic system		
Hose rupture valve: boom	•	•
Overload warning device	•	•
Automatic sensing hydraulic system	•	•
Summation system	•	•
Boom priority	•	•
Arm priority	•	•
Swing priority	•	•
"ECO" mode fuel saving technology	•	•
Boom, arm and bucket regeneration valves	•	•
Swing anti-rebound valves	•	•
Boom and arm holding valves	•	•
Multi-stage filtering system	•	•
Cylinder cushioning	•	•
Cylinder contamination seals	•	•
Auxiliary hydraulic valve	•	•
Automatic two-speed travel motors	•	•
Hydraulic oil, longlife oil 46	•	•
Frame		
Access way with handrail	•	•
Tool storage area	•	•
Punched metal anti-slip plates	•	•
Undercover (heavy-duty)	•	•
Full height counterweight:		
2750 kg	•	
3200 kg		•

	EC160D	EC180D
Cab and interior		
ROPS (ISO12117-2) certified cab	•	•
Silicon oil and rubber mounts with spring	•	•
Travel pedals and hand levers	•	•
Adjustable operator seat with heater and joystick control console	•	•
Control joysticks with 4 switches each	•	•
Heater & air-conditioner, automatic	•	•
Flexible antenna	•	•
AM/FM stereo with CD player and MP3 input	•	•
Hydraulic safety lock lever	•	•
Cab, all-weather sound suppressed, includes:		
Cup holders	•	•
Door locks	•	•
Tinted glass	•	•
Floor mat	•	•
Horn	•	•
Large storage area	•	•
Pull-up type front window	•	•
Removable lower windshield	•	•
Seat belt	•	•
Safety glass	•	•
Sun screens, front, roof, rear	•	•
Rain shield	•	•
Windshield wiper with intermittent feature	•	•
Rear view camera	•	•
Master key	•	•
Undercarriage		
Undercover (heavy-duty)	•	•
Hydraulic track adjusters	•	•
Greased and sealed track link	•	•
Track Guard	•	•
Track shoes		
600 mm with triple grousers	•	•
Digging equipment		
Boom: 5,2 m monoblock	•	•
Arm: 2,6 m	•	•
Manual centralized lubrication	•	•
Linkage	•	•

OPTIONAL EQUIPMENT

	EC160D	EC180D
Engine		
Block heater: 120 V, 240 V	•	•
Diesel coolant heater, 5 kW	•	•
Water separator with heater	•	•
Auto engine shutdown	•	•
Tropical cooling system (50 deg. C)	•	•
Electric		
Extra work lights:		
Cab-mounted 3	•	•
Counterweight-mounted 1	•	•
Travel alarm	•	•
Anti-theft system	•	•
Rotating warning beacon	•	•
Hydraulic system		
Hose rupture valve: arm	•	•
Boom float function with HRV	•	•
Boom float function without HRV	•	•
Hydraulic piping:		
Work tool management system (up to 20 programmable memories)	•	•
Hammer & shear, 1 and 2 pump flow	•	•
Hammer & shear: variable flow and pressure pre-setting	•	•
Additional return filter	•	•
Slope & rotator (40lpm or 60lpm)	•	•
Grapple	•	•
Oil leak (drain) line	•	•
Quick coupler piping	•	•
Volvo hydraulic quick coupler S1	•	•
Volvo hydraulic quick coupler S6	•	•
Volvo hydraulic quick coupler U16	•	•
Hydraulic oil, biodegradable 46	•	•
Hydraulic oil, longlife oil 32	•	•
Hydraulic oil, longlife oil 68	•	•
Cab and interior		
Fabric seat without heater	•	•
Fabric seat with heater and air suspension	•	•
Pilot control pattern change	•	•
Openable roof hatch	•	•
Cab-mounted falling object guard (FOG)	•	•
Cab-mounted falling object protective structure (FOPS)	•	•
Smoker kit (ashtray and lighter)	•	•
Screen guard for front window	•	•
Lower wiper with intermittent control	•	•
Anti-vandalism kit	•	•
Specific key	•	•
Frame		
Full height counterweight: 3200kg	•	
Track shoes:		
500/600/700/800/900 mm with triple grousers	•	
600/700/800/900 mm with triple grousers		•
Digging equipment		
Boom: 5.0 m 2 piece boom	•	•
Arm: 2,3 m; 3,0 m	•	•
Linkage with lifting eye	•	•
Service		
Tool kit, daily maintenance	•	•
Tool kit, full scale	•	•

SELECTION OF VOLVO OPTIONAL EQUIPMENT



VOLVO CONSTRUCTION EQUIPMENT

Volvo Construction Equipment is different. Our machines are designed, built and supported in a different way. That difference comes from an engineering heritage of over 175 years. A heritage of thinking first about the people who actually use the machines. About how to help them be safer, more comfortable, more productive. About the environment we all share. The result of that thinking is a growing range of machines and a global support network dedicated to helping you do more. People around the world are proud to use Volvo.

Not all products are available in all markets. Under our policy of continuous improvement, we reserve the right to change specifications and design without prior notice. The illustrations do not necessarily show the standard version of the machine.

VOLVO

Volvo Construction Equipment
www.volvoce.com

Ref. No 20030374-A
2012.01
Volvo, Global Marketing

English-21
EXC